



OWNERS GUIDE

Winding Drum Residential Elevator

**Series: F008, F021, F022, F115,
F118, F210**

1726 North Ballard Road, Suite 1 • Appleton, WI 54911
Phone 920-991-9082 • Fax 920-991-9087
Technical Support 855-804-5774

Congratulations!

On your choice of your Fox Valley Elevator.

Your elevator is manufactured in accordance with the ASME A17.1/ CSA B44 Safety Code for Elevators and Escalators.

Properly used and maintained, your new elevator will give you many years of excellent service. However, you must be sure to follow all safety procedures.

This Owner's Guide should be reviewed periodically and saved for future reference.

Members Of:

Fox Valley Elevator, is a proud member of The American Society of Mechanical Engineers, The National Association Elevators Contractors, The Canadian Elevator Contractor Association, The Accessibility Equipment Manufacturers Association. These symbols assures you of our commitment to high quality and accessibility to everyone.



Table of Contents

Introduction.....	4
Serial Number	4
Maintenance and Service	4
Important Operating Note.....	5
Safety Features.....	6
Basic Elevator Operating Instructions.....	7
Descriptive Features.....	8-10
Basic Troubleshooting.....	11
Emergency Procedures.....	12-15
Description of Elevator Programs.....	16-20
Is My Elevator safe? True or False Form.....	21-23
Your Elevator 101.....	24
Notes.....	25

*Fox Valley Elevator will be referred as FVE through out the remainder of this document.

Introduction

Your dealer will instruct you on the proper and safe operation of your Fox Valley Elevator. **IT IS IMPORTANT THAT YOU READ THIS *OWNER'S GUIDE* CAREFULLY BEFORE USING YOUR NEW ELEVATOR.**

Your elevator was designed for years of dependable service. However, as with all electrical and mechanical equipment, proper operation and periodic maintenance is absolutely required. Maintenance instructions are available and are to be used by qualified personnel only. For optimal performance, Fox Valley Elevator recommends that you establish a annual maintenance agreement with your elevator contractor.

Elevator Serial Number

This serial number contains specific information about your elevator, allowing technicians to properly identify replacement parts.

Maintenance and Service

Elevator Dealer Information

Company: _____

Address: _____

Contact: _____



















Phone Number: _____

If you have questions concerning the operation or maintenance requirements of your elevator, please contact the local elevator dealer listed above. FVE suggests that you develop an ongoing relationship with your dealer for routine servicing and periodic maintenance. Do not try to service or repair the elevator yourself.

Important Operating Notes



Designates a condition where failure to follow instructions or heed warning could result in serious personal injury or death. When you see this symbol **HEED IT'S MESSAGE**.

-  Anyone using this elevator must be trained on its proper use and have read this owner's guide.
-  Always verify the elevator has properly leveled at the landing (to avoid tripping or falling) before entering or exiting the car.
-  Do not lean against the elevator gate or the control panel.
-  Do not allow unsupervised children to use this elevator.
-  Do not attempt to bypass, or otherwise tamper with, any of the safety systems.
-  Do not exceed maximum capacity of the elevator. A capacity tag is posted in the car.
-  Never open a gate or hoistway door, while the elevator is in motion (it will stop the elevator).
-  The car gate(s) must always be kept in the closed position except during entry and exit of the elevator car. Your elevator will not operate if the gate(s) is not securely closed.
-  If you open the hoistway door and do not open the car gate the elevator will not respond to calls.
-  Do not use your elevator to transport freight that exceeds capacity posted in the elevator car.
-  If you detect a problem with your elevator, do not use it. Call your elevator dealer immediately.
-  Do not use this elevator in the event of fire, smoke, flooding, or earthquake.
-  FVE suggests that you avoid usage of your elevator during severe weather conditions when there is a strong possibility of power surges or outages.
-  Do not use if there is a possibility of weather related damage to the elevator equipment or hoistway (i.e.: flooding, shifted or tilting hoistway walls).
-  Do not use your elevator if the gate switches or hoistway door locks are not operating properly. Call your dealer or service person at once.
-  Never extend parts of the body or any objects through the gate(s) while operating.
-  Safe operation requires a maintained hoistway temperature of between 60° - 110°F with a relative humidity not to exceed 95%.
Note: The frequency drive may be heard running for thermal heat dissipation at any time.
-  Do not expose electrical components to the elements or extreme temperature fluctuations. Resulting condensation will damage equipment, causing it to malfunction. If exposed, let sit for 12-24 hours prior to operation.

Safety Features

Your FVE is equipped with many safety features you should be aware of.

- **Broken Rope Safety.** Mechanically stops the elevator if one or both of the cable(s) breaks or slacks.
- **Car Gate Safety Switch.** The elevator will not operate if a gate is open.
- **Final Limit Switch.** Stops the elevator if unit travels beyond normal operating limits.
- **Hoistway Door Interlocks.** Renders the elevator inoperable while a hoistway door is open, and lock the door when the elevator is not at the floor.
- **Slack Cable Safety Switch.** Electrically prevents the elevator from traveling if the cables become slack or break.
- **Buffer springs.** If present, are device with one or more springs to cushion the impact of descending elevator.
- **Door Fault.** If present, the elevator controller will monitor the door closed and door locked circuit of the hoistway door interlocks on all floor landings. If the elevator detects the door closed circuit open when the elevator is not within the landing zone it will disable the power to the driving machine. When this happens, the elevator will not operate in automatic mode and will need to be reset.
- **Safety Pan.** If present, if the elevator safety pan is triggered by hitting an obstruction in the hoistway. The elevator driving machine power will be disabled until the obstruction is removed and the elevator is reset.
- **Safety Run Timer.** The maximum run time is 120 seconds.
- **Winding Drum Overspeed Braking Device (210 Only).** If present, It's an Independent additional braking system that monitors the speed of the elevator at the powerhead. It will stop the unit if a catastrophic mechanical failure happens to the driving machine.

DO NOT TAMPER WITH ANY SAFETY FEATURE!

Assumption of Risk

ALL PERSONS who use this elevator bear the responsibility for proper use of this product.

Misuse, deliberate or otherwise, voids all warranties... written or expressed!

Fox Valley Elevator, is NOT responsible for any injury or death resulting from product modification, additions or other changes which take place after the product has left the manufacturer's plant.

Basic Elevator Operating Instructions

1. **Press the Call Button** - This will call the elevator to your floor and allow you to open the hoistway door.
2. **Open the Hoistway Door** - Open the door or the auto door will open once the elevator has come to a complete stop at your floor.
3. **Check for Leveling** - Visually verify the elevator has leveled properly, to avoid tripping or falling.
4. **Open the Gate.**
Automatic Gate Operation: The gate will automatically open.
Manual Gate Operation: Slide the gate open. Always use the gate handle.
5. **Enter the Elevator.**
6. **Close the Hoistway Door** - Manually close the door or the auto door will close after you. The elevator will not operate unless the hoistway door is completely closed.
7. **Close the Gate.**
Automatic Gate Operation: The gate operator will automatically close the gate once the hoistway door is closed.
Manual Gate Operation: Slide the gate closed. Always use the gate handle.
8. **Press the Desired Floor Button.**
9. **Complete Travel** - Wait for the elevator to complete its travel to the desired floor and come to a complete stop.
10. **Open the Gate.**
Automatic Gate Operation: The gate will automatically open.
Manual Gate Operation: Slide the gate open. Always use the gate handle.
11. **Check for Leveling** - Visually verify the elevator has leveled properly before stepping out of the elevator to avoid tripping or falling.
12. **Open the Hoistway Door** - Open the door or the auto door will open once the elevator has come to a complete stop at your floor.
13. **Exit Elevator**
14. **Close Gate**
Automatic Gate Operation: The gate operator will automatically close the gate once the hoistway door is closed.
Manual Gate Operation: Firmly close the gate before the hoistway door as you exit the elevator.
15. **Close the Hoistway Door** - Manually close the door securely or the auto door will close for you as you exit the elevator.

Note: The elevator will not respond to another call if the gate to the hoistway door is not completely closed.

If you open the hoistway door and do not open the gate the elevator will not respond to calls.

Note: The descriptions and specifications contained in this guide were in effect at the time the guide was approved for printing. Fox Valley Elevator, reserves the right to discontinue models without notice and without incurring obligation. The equipment described within this guide may not be identified as either standard or optional and the various illustrations may not all be applicable to your particular unit. If you have questions, always check with your Elevator Dealer.

Descriptive Features

It is important that you familiarize yourself with the features of your new FVE before using.



Hall Station

Hall Station should be located near the hoistway door.

- **Car Call Button** - Press this button to call the car to your floor. The button will illuminate while the elevator is in motion or to unlock the hoistway door if the elevator is already at the floor.
- **Car Here Light** - If present, this light will illuminate when the elevator has reached the floor.
- **Key Lock** - Some hall stations may be equipped with an optional key lock. The key must be turned on for the button to become active.
- **Position indicator** - If present, lets you see what floor the elevator is on.
- **Door Fault Light** - If present, this light will illuminate when the door closed circuit is opened with the elevator car not in the landing zone of any floor.
- **Maintenance** - Clean your hall station plate with a clean cloth. Do not use harsh chemicals or abrasive cleaners which may damage the clear coat.



Car Operating Panel

Car Operating Panel will be located inside of the elevator car.

- **Floor Buttons** - Press a floor button to send the car to a floor. The button will illuminate when depressed.
- **Alarm Button** - When pressed, the alarm bell rings alerting others within the home to your need for assistance.
- **Emergency Stop Knob** - Immediately stops the elevator when pushed.
- **Light Switch** - A light switch for your convenience comes standard on all car operating panels.
- **Key Locks** - Optional key locks may be added for controlled access and safety.
- **Position indicator** - If present, lets you know your location as you travel by each floor.
- **Emergency Light** - If present, illuminates if the power goes out.
- **Maintenance** - Clean your car operating panel faceplate with a clean cloth. Do not use harsh chemicals or abrasive cleaners which may damage the clear coat.

Descriptive Features Continued...

Telephone Jack



- **Telephone Jack.** Fox Valley Elevator's are equipped with a telephone jack. Some elevators are equipped with an optional flush mount telephone box (shown here) or a flush mount telephone keypad or integrated into the car operating panel

 A phone must be plugged into the phone jack at all times and the phone line must be operational!

- **Maintenance.** Periodically check to make certain the telephone is in good working order.

GAL Interlock Key



Hoistway Door Interlock

The interlock is located inside the hoistway at the top corner or in the door jamb on the latch side of the door. This locks the hoistway door when the car is not at a landing.

EMI Interlock Key



- **Emergency Key.** Can be used to open the door from outside the hoistway in case of emergency or for servicing.

This key is to be used only for emergencies.

- **GAL Interlock.** Insert the emergency release key into the hole (near the top of the door) and turn (toward the center of the door) to release the interlock while opening the door.
- **EMI Interlock.** Insert the emergency release key into the hole (near the top of the door) and pull center downward to release the interlock while opening the door.
- **Prudhomme Interlock.** Insert the emergency release key into the hole (in the door trim) and turn to release the Prudhomme interlock while opening the door.

Note: Key will only turn one way depending on hand of interlock.

Prudhomme Interlock Key



Accordion Gate

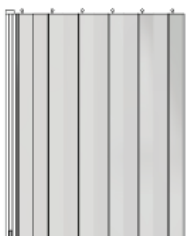

Accordion Gate or Collapsible Gate

(Light curtain included with Collapsible Gate supplied by FVE)

The Accordion Gate and the Collapsible Gate secures the car opening during operation. This gate provides a barrier between the car and the hoistway.

 DO NOT lean on, push on, pull on or open the gate while the elevator is in motion. It can stop the elevator.

Collapsible Gate



- **Maintenance.** Dust and/or clean the surfaces of your gate with a clean cloth. Do not use harsh chemical or abrasive cleaners. Keep the gate tracks clear of dirt or debris.

Descriptive Features Continued...

Automatic Gate Operator



Automatically opens and closes the accordion car gate of the elevator. This option is only available with accordion gates.

- **Convenience.** One less step to remember during the operation of your new elevator.
- **Hands Free.** Very helpful for those with limited mobility and strength.
- **Out of Sight.** The automatic gate operator is mounted on the top of the elevator car.

Automatic Door Operator

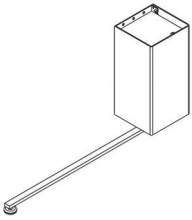

Automatically opens and closes the Hoistway Door of the elevator.

- **Convenience.** One less step to remember during the operation of your new elevator.
- **Hands Free.** Very helpful for those with limited mobility and strength.
- **Versatile .** Can be used with interior or exterior doors.

Basic Troubleshooting

Before Calling for Service...

Verify the elevator has power.

If you open the hoistway door and do not open the gate the elevator will not respond to calls.

Check the red emergency knob on car operating panel by pushing and then pulling the knob back into proper running position.

Verify that all gates and hoistway doors are securely closed by opening and closing the doors and gates. The elevator will not operate if a gate or door is partially open.

Pushing call buttons or floor buttons repeatedly will delay operation and potentially shut down controls. Wait 7 seconds between calls.

Do not attempt to repair the elevator yourself.

If your elevator still will not function call your elevator dealer immediately.

Emergency Procedures

Emergency Battery Lowering of Car

In the case of a power failure, the battery backup allows the elevator's occupant(s) to travel to any chosen floor below the elevator current position. Select the desired floor by pushing the appropriate floor button.

Follow your standard elevator exiting procedures.

Call your dealer for service if the elevator has not reset itself after power is restored and/or if the battery back up systems did not work.

Emergency Manual Lowering of Car

SEVERE INJURY COULD RESULT IF THE ELEVATOR SHOULD START UP OR ENERGIZE IN THE MIDDLE OF AN EMERGENCY EXTRACTION.

- ⚠ Push the Alarm Button to alert others in home that you're in need of help.**
- ⚠ Stay calm and call for help on the telephone.**
- ⚠ This procedure must only be used during an emergency. If the elevator is experiencing stalling call for service immediately.**
- ⚠ Push the emergency stop knob before starting the manually lower procedures.**
- ⚠ The service disconnects (located in the control space) must be in the "OFF" position and the breaker(s) for all elevator circuits must be "OFF" in the main breaker box.**

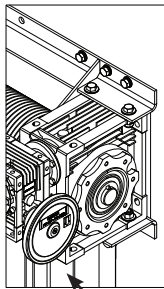

Hand
Crank
Wheel

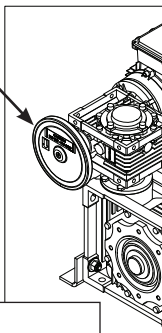

Note:
Use a pair of leather
or work gloves to
help grip the hand
wheel and driving
through the break.

If your elevator stalls between floors and help is available, have them follow the emergency extraction procedure below:

1. Verify that the service disconnect is in the "OFF" position.
 2. Push the Emergency Stop Knob on the Car Operating Panel inside the elevator car.
 3. Open the access door or remove power head cover in the machine room.
 4. DO NOT RELEASE THE BRAKE!
 5. Turn the handwheel until the nearest floor has been reached; downward is easier
- Note:** The arrow on the handwheel should indicate the direction to turn handwheel to move car in downward direction.
6. Close the access door or replace powerhead cover in the machine room.
 7. Call for immediate service of the elevator before continuing to operate the elevator.

Note: Car occupant(s) and rescuer(s)
will need to work together.

Emergency Procedures Continued...

Emergency Opening of the Hoistway Door from Outside the Elevator

The procedure for releasing the interlock will depend on which type of interlock is used with the elevator. All interlocks are designed to be opened from outside of the hoistway door. To open the hoistway door FVE recommends the following procedure:

- ⚠ If you open the hoistway door and do not open the gate the elevator will not respond to calls.

EMI Interlock

If your elevator is equipped with an Electromechanical Interlock (EMI) use the key provided to open the lock from the outside of the hoistway. To open the hoistway door, insert half the length of the key through the hole in the hoistway door. GENTLY pry the outboard end of the key to lift the interlock pin. Slowly open hoistway door with interlock pin raised.

If unable to perform this procedure proceed to the instructions for unlocking the door from within the elevator.

- Call your dealer for service before using the elevator again.

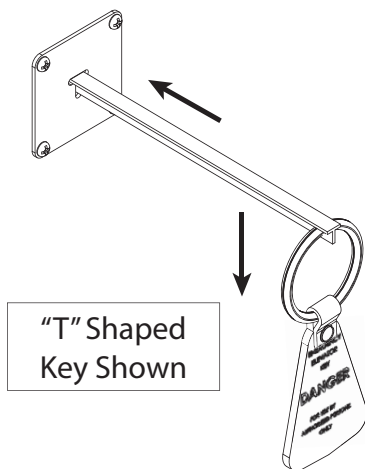

"T" Shaped Key Shown

GAL Interlock

If your elevator is equipped with a GAL "N" Type Interlock, use the key provided to open the lock from outside of the hoistway. Insert the emergency release key with the tooth side at the top into the hole (near the top of the door) and turn (toward the hinge of the door) to release the interlock while opening the door.

- Call your dealer for service before using the elevator again.

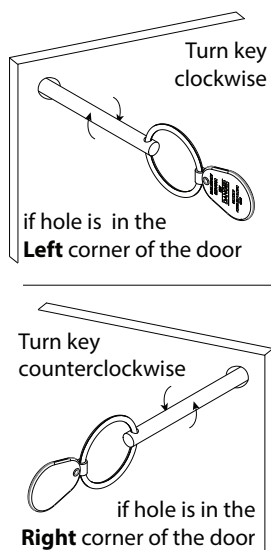

Turn key clockwise

if hole is in the **Left** corner of the door

Turn key counterclockwise

if hole is in the **Right** corner of the door

Emergency Procedures Continued...

Emergency Opening of the Hoistway Door from Outside the Elevator

The procedure for releasing the interlock will depend on which type of interlock is used with the elevator. All interlocks are designed to be opened from outside of the hoistway door. To open the hoistway door FVE recommends the following procedure:

- ⚠ If you open the hoistway door and do not open the gate the elevator will not respond to calls.
-

Prudhomme Interlock

If your elevator is equipped with a Prudhomme Interlock, use the Emergency key provided to open the lock from outside of the hoistway. Insert the emergency key into the hole (in the door frame), interlocking the triangle shapes, and turn key to release the interlock while opening the door.

- Call your dealer for service before using the elevator again.

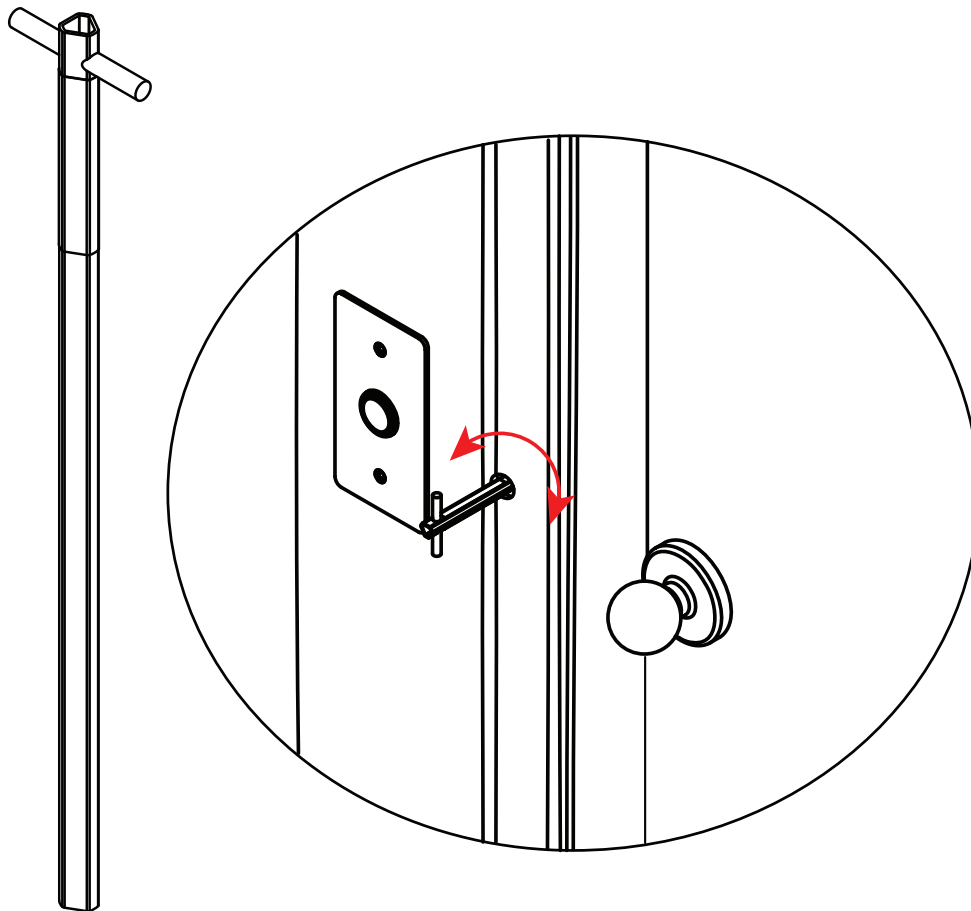

Emergency Procedures Continued...

Emergency Opening of the Hoistway Door from Within the Elevator

- ⚠ Use the phone to call for help before attempting to open the hoistway door from within the elevator.
 - ⚠ Push the Alarm Button to alert others.
 - ⚠ Be sure to push the Emergency Stop Knob. Severe injury could result if the elevator should start up in the middle of an emergency extraction.
 - ⚠ If you open the hoistway door and do not open the gate the elevator will not respond to calls.
-

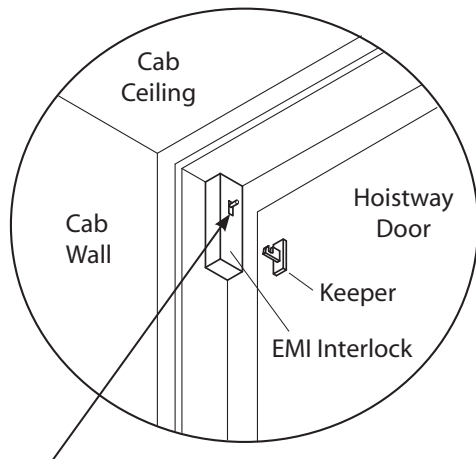

Push the Release Pin Upward

EMI Interlock

- ⚠ Verify the emergency stop knob is in the push in position.

To open the hoistway door from within the car:

- Open the car gate (Resistance may be encountered)
- Lift the release pin and open the hoistway door while the pin is lifted.

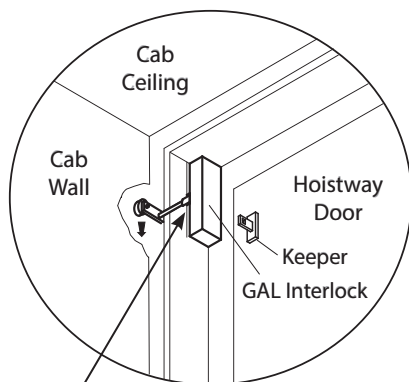

Press the Roller Arm Downward

GAL Interlock

- ⚠ Verify the emergency stop knob is in the pushed in position.

To open the hoistway door from within the car:

- Open the car gate (Resistance may be encountered)
 - **CAREFULLY** reach into the hoistway, and press down on the roller arm
 - Open the hoistway door while holding down on the roller arm
-

Description of Elevator Programs

Automatic Elevator Program

Automatic elevator operation is a program which operates the elevator automatically. This allows use without operating electric switches, and is an optional built in program.

How does the Automatic Elevator Program work?

When the Automatic Elevator Program is turned "ON", the elevator will stop automatically at every floor allowing people to step in and out without having to press any buttons. The elevator will circulate to every floor, with a 5-minute interval between floors, in a continuous loop until the program is turned "OFF" automatically after 30 hours. When the elevator reaches a floor, the door and the gate will open. The door and gate will stay open for an adjustable time of 10 - 120 seconds. While the timer is running you may enter or leave the elevator car. After the timer expires, the door will automatically close followed by the gate. The door or gate must not be obstructed at this time. The elevator will continue the remaining 5-minute floor interval, and will cycle the door and gate one last time before sending off to the next floor. The elevator will continue to run automatically in a continuous program loop.

How does the Automatic Elevator Program affect the elevator when running in Homing Mode?

When the Automatic Elevator Program is activated, the Homing Mode will be ignored until the Automatic Elevator Program is deactivated.

How will manual floor calls effect the Automatic Elevator Program?

Manual floor calls can be placed when the Automatic Elevator Program is activated. The elevator will interrupt the program and travel to the desired destination(s). The elevator will then return to the last floor before the interruption, without cycling the door and gate, and continue the same program loop.

What happens if the automatic gate closing is interrupted?

When the automatic gate operator closes the gate and the gate closing is stopped/obstructed or the break-away is tripped, the elevator program will continue to run but the elevator will not move until the program reaches that floor again internally. The break-away will reconnect itself and continue on with the Automatic Elevator Program.

How does my elevator light work?

When the Automatic Elevator Program is activated the car light will always remain "ON" as long as the light switch on the car operating panel is "ON".

How may I adjust the time period my door stays open?

Please contact your local dealer if you require your interlock timer to be adjusted.

Is my automatic homming timer adjustable?

Yes, the default is set to 30-minutes and can range between 10-60 minutes. It will increase and decrease in 5-minute increments. Please contact your local dealer if you require your homing timer to be adjusted.

Description of Elevator Programs Continued...

Turn the Automatic Elevator Program "ON".

1. Ride the elevator to the top floor that you want the elevator to circulate to in the program loop.

For Example:

If you have a 3 stop elevator you can set the Automatic Elevator Program to circulate the loop between the 1st and 2nd floors, or you can choose to circulate the loop between all three floors.

Please reference the following diagram to see the order sequence of the circulation loop →

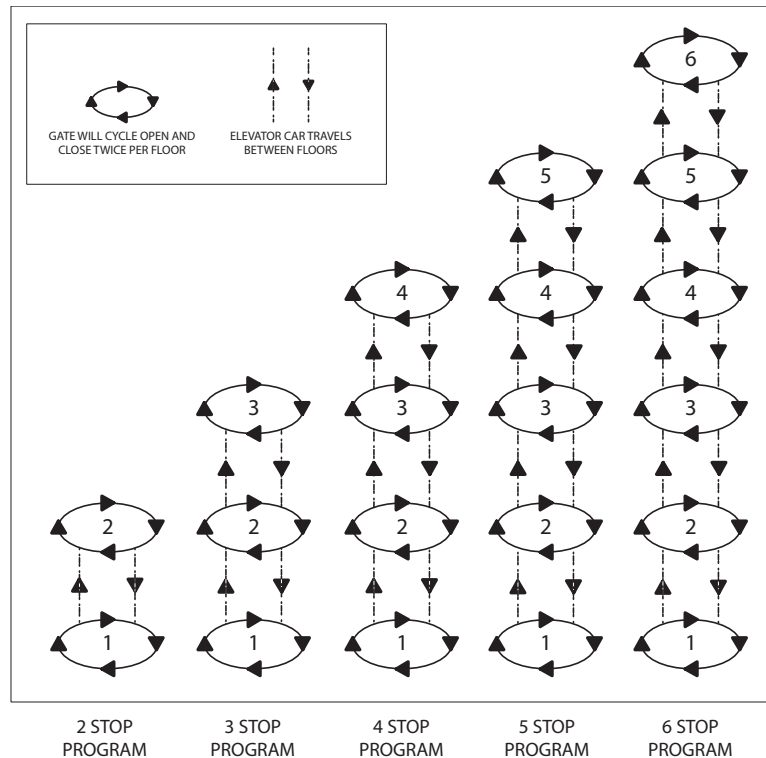

2. Once you arrive at your desired floor, push in the emergency stop knob. Press and hold that floor button for 6 seconds while inside the elevator car. The elevator car lights will turn "OFF" for 2 seconds and back "ON" to acknowledge the Automatic Elevator Program has been activated.
3. Reset the Emergency Stop Knob by pulling firmly.

Note: The elevator will now run automatically from floor to floor because the Automatic Elevator Program is fully activated. You may place calls as desired instead of waiting for the elevator.

Turn the Automatic Elevator Program "OFF".

1. To turn the Automatic Elevator Program "OFF", place a call from within the elevator car to the lowest floor and push in the emergency stop knob.
2. Press and hold the lowest floor button for 6 seconds while inside the elevator car. The elevator car lights will turn "OFF" for 2 seconds and back "ON" to acknowledge the Automatic Elevator Program has been deactivated. The elevator will not run automatically until the Automatic Elevator Program is reactivated.
3. Reset the Emergency Stop Knob by pulling firmly. The flooring homing program is now turned "Off"

Description of Elevator Programs Continued...

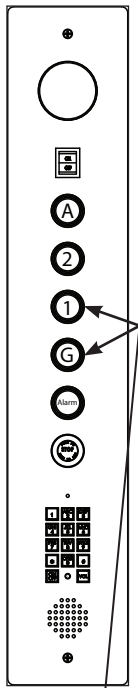

2 lowest floor Car Operating Panel buttons may not be labeled with a 1 & 2

Automatic Homing Feature

After a time of 30 minutes (Timer Default Setting) with no floor calls this feature allows the elevator to home to a floor of your choice. All gates and doors are required to be in the fully closed position for the timer to begin counting. The automatic homing feature will not work if you open the hoistway door and do not open the gate. The homing time can be adjusted between 10 - 60 minutes in 5 minutes increments. Contact your local dealer if you would like to have the homing timer adjusted.

Turn Automatic Homing Feature "On".

1. Call unit to the lowest floor, and open the door and gate.
2. Push the Emergency Stop Knob.
3. Press & hold 2 lowest floor Car Operating Panel buttons (simultaneously) until they illuminate and release.
4. Immediately press the desired home floor call button while 2 lowest floor Car Operating Panel buttons are illuminated. (They will time out in about 6 seconds). This tells the controller which floor will become the home location.
5. The selected automatic homing floor will flash multiple times to acknowledge the homing program has been accepted. If this does not occur repeat previous steps.
6. Reset the Emergency Stop Knob by pulling firmly.
7. Close all gates and doors to start the homing timer.

Turn Automatic Homing Feature "Off".

1. Call unit to the lowest floor, and open the door and gate.
2. Push the Emergency Stop Knob.
3. Immediately press & hold 2 lowest floor Car Operating Panel buttons until they are illuminated (simultaneously). Keep holding them until they turn "Off".
4. Reset the Emergency Stop Knob by pulling firmly. The flooring homing program is now turned "Off"
5. Close all gates and doors.

You Tube Unlinked Instructional Video Links

How to Turn the Automatic Homing ON and OFF

<https://youtu.be/VAgFkdzxrVU>

(The address is case sensitive)

Low Speed EZ Search Feature

If the elevator car stops short of the floor, the controller will initiate the Low Speed EZ Search Feature. The elevator car will begin moving again in the same direction of travel approximately 1/3 of travel speed for 120 seconds, or until the floor is located.

Description of Elevator Programs Continued...

Car Light Time-Out

"On" and
"Off"
Light
Switch on
the Car
Operating
Panel

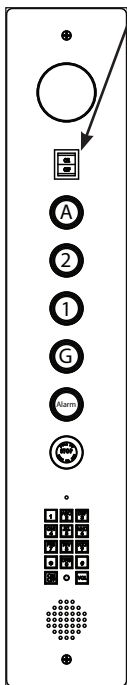

If the car light switch is in the "ON" position and the hoistway door is closed; The car light time-out can be set to turn the lights off. The default is set to 5 minutes and can range between 3-30 minutes. It will increase and decrease in 1 minute increments. If the hoistway door is left open; the lights will stay "ON" until switched "OFF" on your Car Operating Panel or the hoistway door is closed.

Contact your local dealer if you would like to have the Light Time-out adjusted.

Electromechanical Interlock Timer (EMI Timeout)

The interlock timer is an adjustable timer that controls the time period that an Electromechanical Interlock (EMI) will remain unlocked allowing for the door to open. When the unit arrives at the floor, the interlock will remain unlocked for a time period of 10 to 120 seconds. The user will be required to press the immediate floor call button to open the door after the set time period has expired. This feature pertains to the residential elevator program that is equipped with Electromechanical Interlocks (EMI). Some residential applications are equipped with mechanical interlocks that work independently and ignore the interlock timer.

The default is set to 30 seconds and can range between 10-120 seconds. It will increase and decrease in 10 second increments.

Contact your local dealer if you would like to have the EMI Timeout adjusted.

Elevator Entry Monitoring

The elevator control system monitors the car gate(s) and hoistway door locks. Every time the hoistway door opens, the elevator car gate must open.

If this does not happen:

- The elevator will no longer except calls.
- The elevator car can move between floors **up to four times** before the hoistway door and elevator car gate must be opened and closed.
- If either an elevator car gate or hoistway door is left open the elevator will not except calls until either an elevator car gate or hoistway door is closed.

Description of Elevator Programs Continued...

“Door Fault” Light and Resetting the Elevator

(Per State Requirement)

The elevator controller will monitor the door closed and door locked circuit of the hoistway door interlocks on all floor landings. If the elevator detects the door closed circuit opens when the elevator is not within the landing zone, it will disable the power to the driving machine. When this happens, the elevator will not operate in automatic mode.

In the case of a door fault, check that the hoistway is clear above and below the elevator car from any obstructions and hoistway doors are closed on all floor landings before resetting the system. The elevator can be reset with the master key at the key switch which is located on the lower right outside corner of the controller cabinet in the machine room.

Important Notes:

- If you have a “Door Fault” light on the hallstations; it will turn red when the elevator needs to be reset. Once the elevator is reset, the red “Door Fault” light will turn off immediately.
- If you have a Hallstation Position Indicator (PI), an “X” will appear on the display informing you that the elevator will need to be reset. Once the elevator is reset the “X” will remain on the display until the elevator reaches a floor landing.

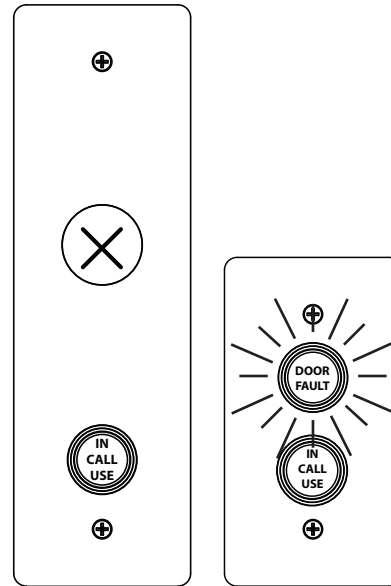

Hallstation Position Indicator (PI) that displays an “X”

Hallstation with red “Door Fault” light

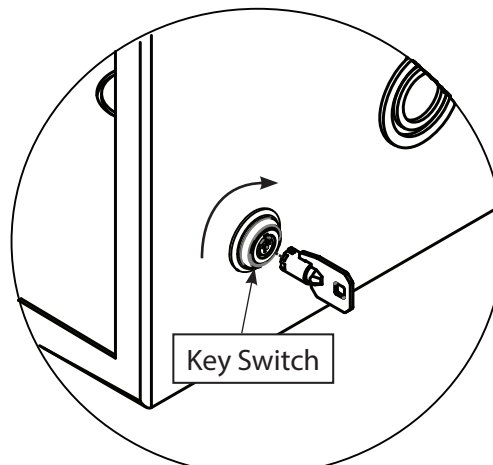

Note: Turn the master key to reset the elevator. Once the elevator is reset; place master key in a safe location.

IS MY ELEVATOR SAFE?

Are **ALL** of the following statements about your elevator **TRUE?**

<u>Check Saftey Features</u>	<u>True/ False</u>
• I cannot open any of the hoistway doors unless the elevator is at that floor landing.	T or F
• If any other doors, access panels, windows, or other access points to my elevator hoistway are opened then my elevator is automatically disabled.	T or F
• My elevator has the required working phone.	T or F
• My elevator's alarm bell rings when the alarm button is pressed.	T or F
• My elevator emergency stop button disables my elevator.	T or F
• My elevator runs only with the gate(s) closed and all the hoistway doors closed.	T or F
• If my elevator has a light curtain, my elevator stops when the light curtain is obstructed.	T or F

**PLEASE REFERENCE THE "YOUR ELEVATOR 101" DIAGRAM
IN THE BACK OF THE OWNERS GUIDE.
IF YOU ANSWERED FALSE OR NEED HELP TO ANSWER THE ABOVE
QUESTIONS, PLEASE CONTACT YOUR ELEVATOR DEALER.**

IS MY ELEVATOR SAFE?

Are ALL of the following statements about your elevator TRUE?

<u>Check Installation</u>	<u>True/ False</u>
• My elevator has been installed and serviced by a factory trained technician.	T or F
• My elevator hoistway is fully enclosed.	T or F
• If my elevator is of the winding drum type, the machine room has a lockable entry door.	T or F
• My elevator gate does not allow me to push a three inch diameter ball through it anywhere within the gate up to a height of 67 inches.	T or F
• My elevator is used for a single family residence.	T or F
• When I stand inside the elevator and open the gate and close the hoistway door, I can measure from the surface of the door to the landing edge and that measurement is 3/4" inches or less.	T or F
• I know where my Owner's Manual is located.	T or F
• I and members of my family have read my Owner's Manual entirely and completely understand its contents.	T or F

**PLEASE REFERENCE THE "YOUR ELEVATOR 101" DIAGRAM
IN THE BACK OF THE OWNERS GUIDE.
IF YOU ANSWERED FALSE OR NEED HELP TO ANSWER THE ABOVE
QUESTIONS, PLEASE CONTACT YOUR ELEVATOR DEALER.**

IS MY ELEVATOR SAFE?

Are ALL of the following statements about your elevator TRUE?

<u>Check Maintenance</u>	<u>True/ False</u>
• I have hired someone to maintain my elevator to manufacture recommended factory specifications.	T or F
• My elevator machine room is clutter free, pest free and well lit.	T or F
• My elevator machine room is free from any drips or puddles of any type.	T or F
• There are no apparent electrical hazards in my elevator machine room.	T or F
• The equipment in my elevator machine room is rust free.	T or F
• My elevator levels at the floors accurately.	T or F
• My elevator responds to calls.	T or F
• My elevator car lights work.	T or F
• My elevator gate is free from defects or broken pieces.	T or F
• My elevator gate is in good working order and condition.	T or F
• All of the visible elevator mounting hardware is securely fastened. For example, the handrail and interlock.	T or F
• My elevator is free of any unusual noises.	T or F
• My elevator car is free from any damage.	T or F
• My elevator hoistway doors have a working latch set.	T or F

**PLEASE REFERENCE THE “YOUR ELEVATOR 101” DIAGRAM
IN THE BACK OF THE OWNERS GUIDE.
IF YOU ANSWERED FALSE OR NEED HELP TO ANSWER THE ABOVE
QUESTIONS, PLEASE CONTACT YOUR ELEVATOR DEALER.**

Your Elevator 101

Hall Station
"Calling the Elevator" or Call Button
 Pressing the call button in the hallway will "call the elevator" to you.

C.O.P.
 The Car Operating Panel (C.O.P.) is the control panel inside the elevator that houses the floor landing buttons, the light switch, the alarm button and emergency stop switch.

Elevator Car
 The elevator car transports passengers from one floor landing to another.

Floor Landing
 A term used to describe each floor on which the elevator will open.

Rail
 The rail is steel track that guides the elevator when it travels up and down.

Controller
 The controller houses the electrical control circuits of the elevator.

Service Disconnect
 Located near the controller in the machine room. The disconnect is the main power switch to the elevator.

Power Unit
 This drive system could consist of a hydraulic system or winding drum system with wire rope to raise and lower the elevator car.

Sling
 The Sling is an L-shaped steel support that holds the elevator car and is attached to the rail system.

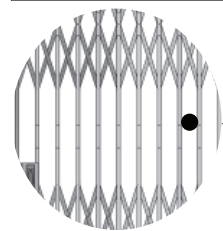

A 3" ball in diameter can NOT fit through anywhere within the gate.

Electromechanical Interlock
 Often referred to as an EMI, is an electromechanical safety lock that prevents the hoistway door (hall door) from opening if the elevator is not at that floor landing.



Private Residence
 A separate dwelling or separate apartment in a multiple dwelling that is occupied only by the members of a single family unit.

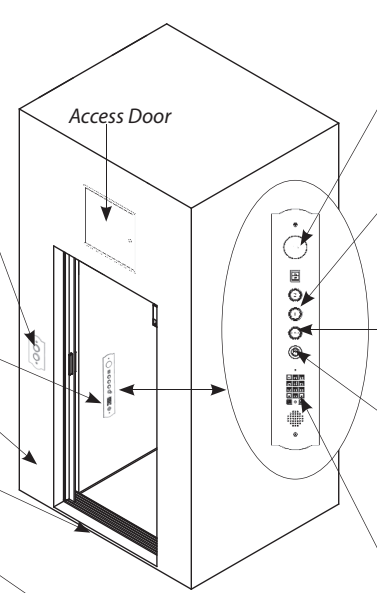

Emergency Light
 The emergency light illuminates if the power goes out.

Floor Landing Buttons
 By pressing the floor landing buttons on the C.O.P. inside the elevator car; The elevator car will take you to the desired floor landing.

Alarm Button
 When you push the alarm button on the C.O.P. inside the elevator car the alarm bell rings alerting others within the home to your need for assistance.

Emergency Stop
 When disabled it prevents the user from moving an elevator or initiating movement of the elevator.

Telephone
 The phone is to place a call during an emergency.

Hoistway
 An opening through a building or structure for the travel of elevators and dumbwaiters extending from the pit floor to the roof or floor above.

Pit
 The pit provides clearance for support components that are below the floor of the elevator car allowing the elevator floor to level with the lowest landing.

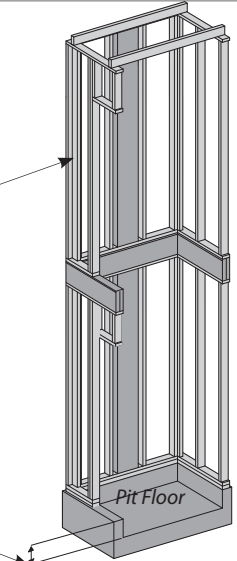

Gate
 The gate secures the opening of the car while the elevator is in operation.

Note:
 Distance between the face of the hoistway door and the edge of the landing sill not to exceed 3/4".

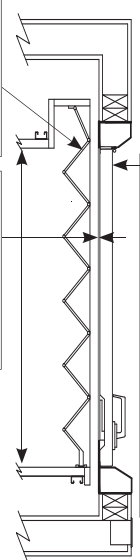

Hoistway Door
 Often referred to as hall door, the hoistway door allows access to the hoistway and is prevented from opening unless the elevator stopped at that particular floor landing.

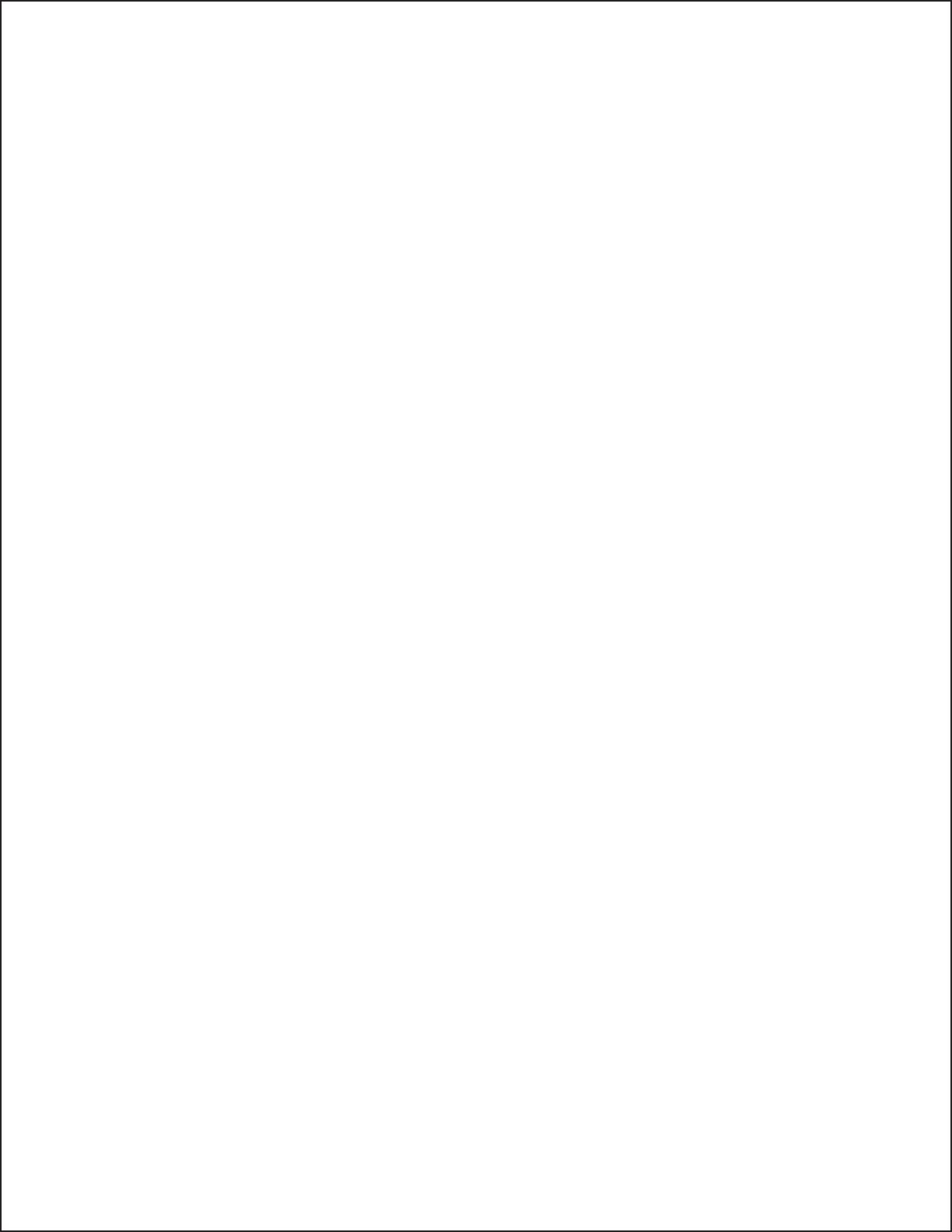

1726 North Ballard Road, Suite 1 • Appleton, WI 54911-2404
Phone 920-991-9082 • www.foxvalleyelevator.com

PM0007-H
11 APR 2022